



# Instruction manual and data sheet

## Torque Sensor Series 2000



PREMIUM QUALITY  
MADE IN GERMANY



Copyright ©

NCTE AG® Torque Sensor Series 2000 Instruction Manual and Data Sheet.

This instruction manual is property of NCTE AG®,

D-82041 Oberhaching

Unauthorized duplication, even in part, is not permitted.

State: February 2022

## Instruction manual

1	General .....	5
1.1	Customer service address.....	5
1.2	Warranty.....	5
1.3	Scope of delivery .....	5
1.4	Declaration of conformity .....	6
2	Safety.....	7
2.1	Intended use.....	7
2.2	Recalibration and duration of use .....	7
2.3	Structural change.....	7
2.4	Training of the operating personnel.....	7
2.5	Transport and handling .....	7
3	Torque Sensor Series 2000 .....	8
3.1	Short description .....	8
3.2	Assembly and disassembly .....	8
3.3	Interface description .....	8
3.4	Starting up .....	8
3.5	Operation during regular mode.....	9
3.6	Irregular operation, actions in case of failures.....	9
3.7	Safety instructions.....	9
3.8	Shaft preservation .....	9
3.9	Service, maintenance and repair .....	9
3.10	Disposal.....	10

## Data sheet

1	Key Facts .....	11
2	Torque ranges.....	11
3	Load characteristics .....	12
4	Technical characteristics.....	12
5	EMV Emission data .....	13
6	Dimensions .....	14
7	Wiring diagram .....	15
8	Sensor wiring .....	15
9	Order options .....	16
10	Accessories .....	17

## Instruction manual

### 1 General

Dear customers,

Thank you for your decision to buy our sensor products. You have chosen a high quality and extremely precise torque measuring system.

This manual contains all the information necessary for you and the installation, operating and maintenance personnel to use your measuring system under the intended conditions of use. It contains important information to ensure proper and safe installation and operation.

For these reasons, the Instruction manual must always be available at the place of use of the torque measuring system and always ready to hand.

We reserve the right to make changes in the course of product improvements. We try to maintain compatibility with previous versions. All information without guarantee subject to technical changes.

For further questions, we are of course also available after the purchase at any time.

Please use our contact address

#### 1.1 Customer service address

NCTE AG  
Raiffeisenalle 3  
D-82041 Oberhaching

Phone: +49 (0)89 665 619 0

Email: [sales@ncte.de](mailto:sales@ncte.de)

Web: <https://ncte.com/>

#### 1.2 Warranty

The warranty period is 12 months from the date of delivery from the factory, provided that the product is used in accordance with its intended purpose, in compliance with the maintenance and calibration regulations and the General Terms and Conditions of Business.

You can find these, current instruction manuals and data sheets on:

<https://ncte.com/en/standard-products/#>

#### 1.3 Scope of delivery

The torque sensor system consists of a calibrated sensor, signal acquisition / -processing integrated in the housing, a 5 m long connection cable with plug (Binder plug no. 99-0426-10-08) and keystone (round shaft) or square sleeve (square shaft).

Enclosed you will find the corresponding calibration certificate and the warning notes.

## 1.4 Declaration of conformity

The manufacturer

NCTE AG  
Raiffeisenalle 3  
D-82041 Oberhaching

hereby declares that the following product

Product designation:	Torque sensor series 2000	
Trade designation:	Series 2000	
Model names:	2100-2.5	2200-2.5
	2100-5	2200-5
	2100-7.5	2200-7.5
	2100-15	2200-17.5
	2100-60	2200-75
	2100-140	2200-175
		2200-250
	2100-400	2200-500

conforms to the requirements of the EMC Directive 2014/30/EU – including its amendments in force at the time of this declaration.

The following harmonized standards were applied:

EN 61000-6-2:2019-11  
EN 61000-6-4:2020-09  
EN 61326-1:2013-07  
EN 61326-1:2018-09 (Draft)

The following national laws, standards and specifications were applied:

Electromagnetic compatibility law – EMCG

Place: Oberhaching  
Date: January 20<sup>th</sup> 2022



\_\_\_\_\_  
Dr. Jürgen Uebbing, CEO



\_\_\_\_\_  
Mr. Bernhard Mayr, Technical Director

## 2 Safety

Please note the enclosed sheet on the warning notes.

### 2.1 Intended use

The sensors of the series 2000 are designed exclusively for measuring torque and/or speed. The respective load range can be taken from the data sheet and must not be exceeded.

Proper use also includes compliance with the commissioning, assembly, operating, ambient and maintenance conditions specified by the manufacturer.

Any use beyond these is considered improper. The manufacturer is not liable for any damage resulting from such use.

### 2.2 Recalibration and duration of use

A factory recalibration should be executed annually. See the corresponding label on the sensor.

This recalibration can be carried out quickly and easily by NCTE AG.

Please contact us.

If the sensor is used within the limits of its intended use and regularly calibrated, the sensor's operating life is unlimited.

### 2.3 Structural change

Unauthorized conversions or changes to the torque measuring system are prohibited for safety reasons and lead to the immediate expiration of the warranty claims.

### 2.4 Training of the operating personnel

Assembly, commissioning and maintenance personnel must have read and understood the complete operating instructions, especially Chapter "2 Safety". The operator is recommended to have this confirmed in writing.

### 2.5 Transport and handling

During handling, storage and transport, make sure that the sensor is not exposed to strong magnetic or electromagnetic fields (e.g. degaussing coils).

### 2.6 Safety equipment

When handling the sensors gloves are to be worn.

## 3 Torque Sensor Series 2000

The Series 2000 provides the easiest and most cost-effective entry into torque measurement technology.

### 3.1 Short description

The series is mainly used in test stands, automation processes, production lines e.g. end-of-line tests and teaching.

Torque measurement is possible both statically and dynamically. The mechanical connection is made via a square shaft (series 2100) or round shaft (series 2200).

The Series 2000 provides an analogue output signal with +/-10 V, +/-5 V, 0-10 V or 0-5 V.

The sensor is delivered as a ready-to-connect unit including 5m cable, keystones (round shaft) and calibration certificate.

### 3.2 Assembly and disassembly

When mounting the sensor, make sure that the measuring shaft is exactly aligned with the connecting shafts (corresponding couplings can be found in the accessories). It must then be possible to push the key adapters / square ends of the connection shafts onto the key adapter connections / square connections of the sensor without any effort. No force must be exerted on the housing in the axial direction during fastening. The sensor can be secured against rotation by means of the flat surface (optional sensor holder). The cable length must not exceed 5m. Using a cable other than the one supplied by NCTE or an identical cable with a different cable length may impair the function of the sensor system.

The disassembly may only be done without applying torque to the measuring shaft.

### 3.3 Interface description

Mechanical interfaces:

For power transmission, adapter connections are provided at both ends of the keystone round shafts. In respect to square sensors, the shaft has square ends.

Electrical interface:

A socket for power supply and signal output is attached to the upper side of the housing.  
(Pin assignment see Chapter "7 Wiring diagram")

### 3.4 Starting up

After mounting the sensor, the following must be observed:

- Switch on power supply and check voltage value.  
(Voltage peaks at the sensor must be avoided, devices must be checked accordingly before connection to the sensor)
- Connect the sensor to the power supply. (using the cable supplied).
- Record the output signal of the sensor with high resistance.  
(e.g. A/D converter, oscilloscope, PC measuring card)
- Record output signal in mechanically unloaded state of the sensor.



### 3.5 Operation during regular mode

Optimal measuring values are achieved when the sensor is used while maintaining the specific nominal torque. If the permissible operating conditions are observed, the sensor operates trouble-free and maintenance-free.

### 3.6 Irregular operation, actions in case of failures

If the sensor is mechanically overloaded (e.g. if the maximum permissible longitudinal force or torque limit is exceeded or if there are strong vibrations), the sensor may be damaged and the signal output may be distorted. In this case do not open the device. Contact NCTE AG directly.

### 3.7 Safety instructions

The following safety instructions should be followed for smooth operation:

- Opening the sensor or even single screws is not allowed.
- The shaft retaining rings on the shaft ends must not be loosened.
- The fastening nut of the plug must not be loosened or tightened.
- Only use power supplies safely disconnected from the mains voltage.
- Regarding the electrical and mechanical load of the sensor, the specifications according to the sensor-specific nameplate and the table in Chapter “4 Technical characteristics” must be observed.
- The sensor is not to be used as support bearing. The existing fastening options serve exclusively to secure the housing against twisting.
- To protect your system, we recommend increasing the torque over several stages.

### 3.8 Shaft preservation

The shafts are protected on both sides with a film of anti-corrosion wax. We recommend to leave the protection permanently. If technically necessary, remove the protective film with spirit/ethanol.

### 3.9 Service, maintenance and repair

As part of your test and measurement equipment management, we recommend regular inspection of your test and measurement equipment. Please also observe the relevant standards and guidelines.

#### **Maintenance plan by NCTE AG**

Calibration:	Every 12 months
Check the wiring, connectors and shaft:	Every 12 months

Repairs and recalibrations can only be carried out by NCTE AG personnel.

### 3.10 Storage

The sensors must be stored in their packaging, in a clean and dry environment without external magnetic fields, moisture, heat and cold. The sensors are to be stored between -30 ... +85 °C.

### 3.11 Disposal

The device must be returned to **NCTE AG, Raiffeisenallee 3, D-82041 Oberhaching** for disposal.

## Data sheet

### 1 Key Facts

Technical	Distinctive features
<ul style="list-style-type: none"> <li>Nominal torque: up to 500 Nm, bidirectional</li> <li>Speed: ≤ 5000 rpm</li> <li>Accuracy: ≤ ±1 %</li> <li>Operating temperature: -30 °C to +85 °C</li> <li>Protection class: IP50</li> <li>Output signal: +/-10 V, +/-5 V, 0-10 V or 0-5 V</li> <li>Cut-off frequency: 1.000 Hz</li> </ul>	<ul style="list-style-type: none"> <li>Made in Germany</li> <li>Short delivery time (&lt; two weeks)</li> <li>Excellent price/performance ratio</li> <li>No external measuring amplifier necessary (Plug &amp; Play)</li> <li>Completely contactless measuring system</li> <li>Delivery including 5 m cable and calibration certificate</li> <li>Suitable accessories (bracket, readout unit, couplings)</li> </ul>

### 2 Torque ranges

Model line Series 2100 Square shaft	Nominal torque bidirectional (+/-) [Nm]	Limit torque unidirectional [Nm]	Limit torque bidirectional (+/-) [Nm]	RPM [rpm]
¼ inch	2.5	2.5	2.5	1000 (A higher speed is possible with backlash-free adaptation)
	5.0	5.0	5.0	
	7.5	7.5	7.5	
	15	15	10	
⅜ inch	60	60	40	
½ inch	140	140	85	
¾ inch	400	400	270	

Note: Series 2100 sensor versions are calibrated to nominal torque. However, the absolute operating limits are as shown in the table above. Do not exceed the specified magnitude of the limit torques for unidirectional and bidirectional loading.

Model line Series 2200 Round shaft	Nominal torque bidirectional (+/-) [Nm]	Limit torque unidirectional [Nm]	Limit torque bidirectional (+/-) [Nm]	RPM [rpm]
∅ 9 mm	2.5	3.25	3.25	5000
	5	6.5	6.5	
	7.5	9.75	9.75	
	17.5	19.5	19.5	
∅ 14 mm	75	97.5	97.5	
∅ 19 mm	175	227.5	227.5	
	250	325	325	
∅ 25 mm	500	650	650	

Note: In case of overload, the sensor leads to a measurement offset. In this case the sensor must be recalibrated at NCTE AG. The sensor may only be operated within the specified nominal torque range.

### 3 Load characteristics

Model line Series 2100 Measuring range	Axial force [N] <sup>1</sup>	Limit transverse force [N]	Limit bending moment [Nm]
2.5 and 5	1000	20	2.5
7.5	1000	30	3.7
15	1000	100	12.5
60	2600	300	41.7
140	4000	500	89.5
400	7000	800	176

Model line Series 2200 Measuring range	Axial force [N] <sup>2</sup>	Limit transverse force [N]	Limit bending moment [Nm]
2.5 and 5	1000	20	2.5
7.5	1000	30	3.7
17.5	1000	100	12.5
75	2600	300	41.7
175 and 250	4000	500	89.5
500	7000	800	176

Any irregular stress (bending moment, transverse or axial force, exceeding the nominal torque) up to the specified static load limit is only permissible as long as none of the other stresses can occur. Otherwise the limit values must be reduced. If 30 % of the limit bending moment and 30 % of the limit transverse force are present in each case, only 40 % of the axial force is permissible, whereby the nominal torque must not be exceeded.

### 4 Technical characteristics

No.	Accuracy class <sup>3</sup>		1,0
	Description	Unit	Value
1	Linearity deviation incl. hysteresis	%ME <sup>4</sup>	< ±1.0
2	Rotational Signal Uniformity (RSU)		< ±1.0
3	Repeatability		< ±0.05
Output signal general		Unit	Value
4	Cut-off frequency, -3dB point, Bessel characteristic	Hz	1000
5	Analog signal	V	+/-10, +/-5, 0-10 or 0-5
6	Signal at torque = zero <sup>5</sup>	V	0, 5 or 2.5
7	Signal at positive nominal torque <sup>5</sup>	V	9 or 4.5
8	Signal at negative nominal torque <sup>5</sup>	V	-9, -4,5, 1 or 0,5
9	Calibration parameter (normed) <sup>5</sup>	mV/Nm	Refer to calibration certificate
10	Output resistance	Ω	50

<sup>1</sup> Specified values only apply to direct axial force on the shaft. If the axial force acts on the circlip, only 50 % of the force is permissible.

<sup>2</sup> Specified values only apply to direct axial force on the shaft. If the axial force acts on the circlip, only 50 % of the force is permissible.

<sup>3</sup> The accuracy class means that the linearity deviation as well as the circulation modulation, individually, are each less than or equal to the value specified as the accuracy class. The accuracy class must not be confused with a classification according to DIN 51309 or EA-10/14.

<sup>4</sup> %ME: Related to the measuring range.

<sup>5</sup> The exact sensor-specific values can be found in the calibration certificate supplied.

Effect of temperature		Unit	Value							
11	Zero point drift over temperature	%/10 K	< 0.5							
12	Signal drift over temperature within nominal temperature range	%/10 K	< 0.5							
Power supply		Unit	Value							
13	Supply voltage	VDC	6 ... 28							
14	Current consumption (max.)	mA	25							
15	Start-up peak	mA	< 50							
16	Absolute max. supply voltage	VDC	28							
General information		Unit	Value							
17	Protection class according to EN 60529 <sup>6</sup>	IP	50							
18	Reference temperature	°C	+15 ... +35							
19	Operation temperature range	°C	-30 ... +85							
20	Storage temperature range	°C	-30 ... +85							
Nominal torque (bi-directional) Square shaft		Nm	2.5	5	7.5	15	60	140	400	
21	Weight	g	395	401	414	652	754	878		
22	Moment of inertia	g mm <sup>2</sup>	582	648	904	3.339	13.294	57.770		
Nominal torque (bidirectional) Round shaft		Nm	2.5	5	7.5	17.5	75	175	250	500
23	Weight	g	386	392	400	685	856	1.230		
24	Moment of inertia	g mm <sup>2</sup>	597	662	1.073	4.922	19.126	79.754		

## 5 EMV Emission data

EMV immunity and emitted interference (DIN EN IEC 61000-6-2 / DIN EN IEC 61000-6-4 / DIN EN 61326-1)

Examination	Test specification	Admission	Evaluation criteria
Discharge of static electricity (ESD)	IEC 61000-4-2	± 6 kV Contact discharge	<b>B</b> passed
Electromagnetic HF-field	IEC 61000-4-3	80 - 3000 MHz; 10 V/m; 80% AM	<b>A</b> passed
Rapid transients	IEC 61000-4-4	± 2 kV	<b>B</b> passed
High frequency, asymmetrical	IEC 61000-4-6	0.15 - 80 MHz; 10V; 80% AM	<b>A</b> passed
Examination	Test specification	Admission	Evaluation criteria
Interference voltage 0.15 - 30 MHz	CISPR 11:2015 + A1:2017	<b>Class B</b>	Limit values observed
Radio interference field strength 30 - 1000 MHz	CISPR 11:2015 + A1:2017	<b>Class B</b>	Limit values observed

<sup>6</sup> Wiring connected.

## 6 Dimensions

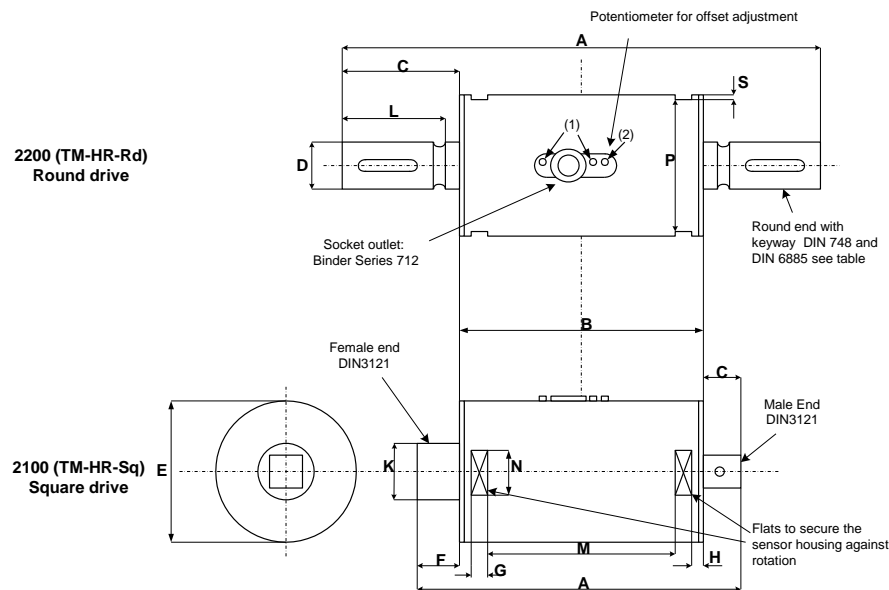

Dimensions	Series 2100 Square shaft				Series 2200 Round shaft			
Shaft size	1/4 inch	3/8 inch	1/2 inch	3/4 inch	∅ 9 mm	∅14 mm	∅19 mm	∅25 mm
Nominal torque [Nm]	2.5/5/ 7.5/15	60	140	400	2.5/5/ 7.5/17.5	75	175-250	500
A	95.5	107	123.5	146	125	139	179	220
B	70	70	70	87	70	70	70	87
C	9.5	13	18,5	29.6	27.5	34.5	54.5	66.6
D	-	-	-	-	9g6	14g6	19g6	25g6
E	40	50	50	60	40	50	50	60
F	16	24	35	29.6	-	-	-	-
G	8	8	8	10,5	8	8	8	10.5
H	5	5	5	2	5	5	5	2
K	12	18	24	33.5	-	-	-	-
L	-	-	-	-	23	30	50	-
M	43.9	43.9	43.	61.4	43.9	43.9	43.9	61.4
N	15	18	18	19	15	18	18	19
P	37	47	47	57	37	47	47	57
S	1.5	1.5	1.5	1.5	1.5	1.5	1.5	1.5

### Series 2200

Dimensions keystone [mm]				Keystone		
Round shaft	Width	Depth	Length	Height	Length	Amount
∅ 9 mm	3	1,8	18,5	3	18	1
∅ 14 mm	5	3	25,5	5	25	1
∅ 19 mm	6	3,5	45,5	6	45	1
∅ 25 mm	8	4	50,5	7	50	2

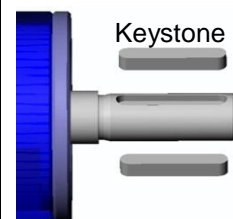

For high alternating loads, torque transmission by positive and frictional locking via a suitable fit or coupling is recommended.

## 7 Wiring diagram

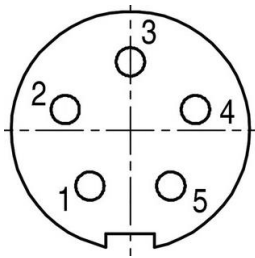

Connector  
Power supply and outputs

Type: Binder Plug Series 712-M9 IP67 (Colour coding acc. to DIN 47100)			
Pin	Colour	Description	Value
1	White	Supply voltage $V_{CC}$	6 V – 28 V
2	Brown	Output signal analogue	-
3	Black	Supply voltage GND	-
4	Blue	Not required	-
5	Grey	Reference voltage $V_{ref}$	2.5 V

The output  $V_{ref}$  is a constant 2.5 V output and represents the virtual zero point for direct +/- torque measurement for the 0-5 V type sensor.

## 8 Sensor wiring

For 0-5 V type sensor:

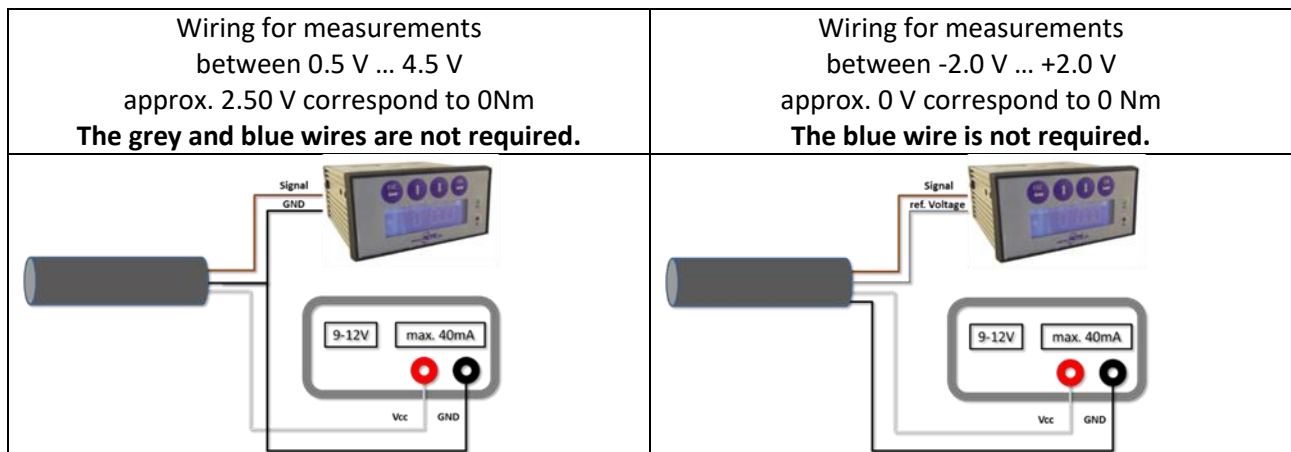

For 0-10 V type sensor:

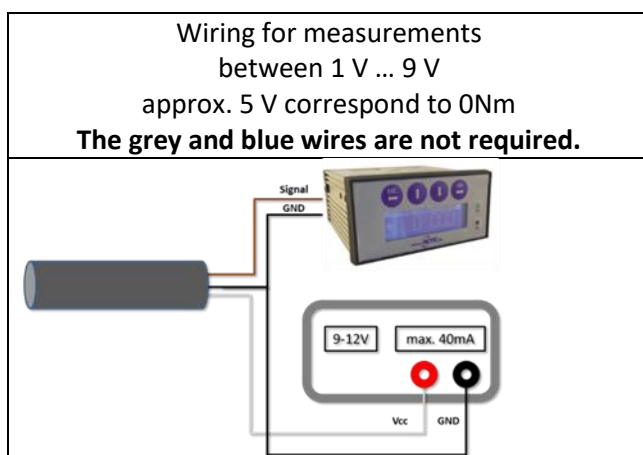

At the moment there is no readout unit available for the +/- 10 V and +/- 5 V type sensors.

## 9 Order options

Series 2100 (Square shaft)			
<b>Measuring range [Nm]</b>			
2.5	including 5m cable and calibration certificate		
5	including 5m cable and calibration certificate		
7.5	including 5m cable and calibration certificate		
15	including 5m cable and calibration certificate		
60	including 5m cable and calibration certificate		
140	including 5m cable and calibration certificate		
400	including 5m cable and calibration certificate		
<b>Output signal analog</b>			
A1	Voltage output +/-10 V		
A2	Voltage output +/-5 V		
A3	Voltage output 0-10 V		
A4	Voltage output 0-5 V		
2100	15	A1	Example sensor configuration



Series 2200 (Round shaft)			
<b>Measuring range [Nm]</b>			
2.5	including 5m cable and calibration certificate		
5	including 5m cable and calibration certificate		
7.5	including 5m cable and calibration certificate		
17.5	including 5m cable and calibration certificate		
75	including 5m cable and calibration certificate		
175	including 5m cable and calibration certificate		
250	including 5m cable and calibration certificate		
500	including 5m cable and calibration certificate		
<b>Output signal analog</b>			
A1	Voltage output +/-10 V		
A2	Voltage output +/-5 V		
A3	Voltage output 0-10 V		
A4	Voltage output 0-5 V		
2100	15	A1	Example sensor configuration

We would be pleased to provide you with further information about serial products in a personal contact under

Phone: +49 (0)89 66 56 19 30 or by e-mail: [sales@ncte.de](mailto:sales@ncte.de).



## 10 Accessories

Bracket		
		
1	2.5 – 17.5 Nm (Art. No.: 400006081)	
2	75 – 250 Nm (Art. No.: 400006082)	
Readout unit		
		
1	Order number 400010-ATS001 (Art. No.: 400010005)	<p>The NCTE readout unit is a multifunctional readout unit for the NCTE torque sensors. Torque, angle or speed can be displayed. The measured data can be stored on an inserted SD flash memory card or sent directly to a PC in real time via a USB interface.</p> <p>The readout program is available for download on the NCTE-Website (<a href="https://ncte.com/service/#zubehor">https://ncte.com/service/#zubehor</a>)</p> <p>At the moment there is no readout unit available for the +/- 10 V and +/- 5 V type sensors.</p>
Couplings		
		
coupling types	Used for	D2 max.
KB2/45-41-9-D2	2000 – D9	16
KB2/100-47-9-D2	2000 – D9	25
KB4C/18-59-9-D2	2000 – D9	25.4
KB4C/80-78-14-D2	2000 – D14	42
KB4C/200-83-19-D2	2000 – D19	45
KB4C/300-94-19-D2	2000 – D19	60
KB4C/500-100-25-D2	2000 – D25	70

You can obtain further or additional accessories and special requests in a personal discussion with your contact person for series products by calling +49 (0)89 66 56 19 30 or by e-mail: [sales@ncte.de](mailto:sales@ncte.de).

Your experts for magnetostrictive sensors

